



GABRIEL SCOTT

EST. 2012



## BARDOT

### Barstool

in Blackened Steel, Satin Nickel & Nude Leather

The epitome of chic, with distinct legs and a beautiful silhouette, the Bardot series is aptly named after the French style icon.

Strutting atop a base of black steel with distinct brass, copper or nickel hardware; thin profiled seats and back cushions are hand stitched in fine pebbled vegan leather – available in nude, gray, navy or black options. Available in chair, counter-height and bar-height stool options.

All Gabriel Scott pieces are handmade in Canada.

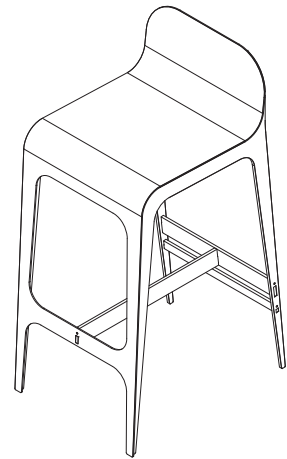
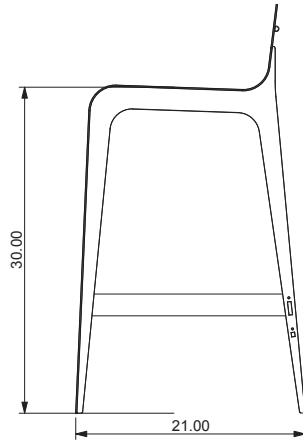
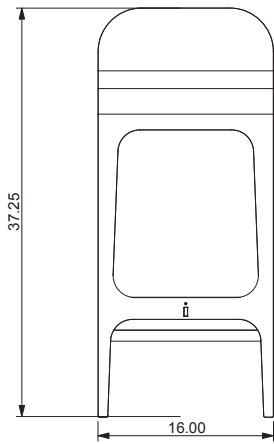

## SPECIFICATIONS

### Standard Finishes:

Metal: Blackened Steel, Satin Nickel,  
Satin Brass or Satin Copper

Vegan Leather: Black, Navy, Gray or Nude

### Specifications:

Dimensions: 16" x 21" x 37.25" H

41 cm x 53 cm x 94 cm H

Weight: 33 lbs / 15 kg

Standard lead time: 8 - 10 weeks

Custom finishes available upon inquiry.

Made and assembled in Canada.

## STANDARD FINISHES

### Metal:

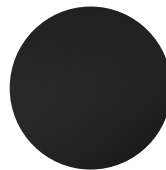

Blackened Steel -  
Base/ Hardware

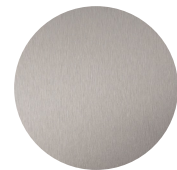

Satin Nickel -  
Hardware



Satin Brass -  
Hardware



Satin Copper -  
Hardware

### Vegan Leather:

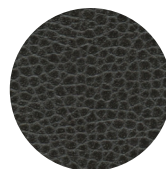

Black - Pebbled  
Vegan Leather

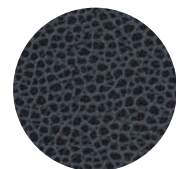

Navy - Pebbled  
Vegan Leather

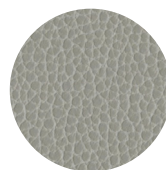

Gray - Pebbled  
Vegan Leather

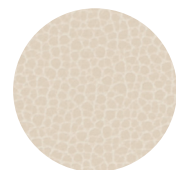

Nude - Pebbled  
Vegan Leather