

Flush Globe 12"



ALLIED MAKER

WAC-021



**MATERIALS**

Glass, Wood

**GLASS FINISHES**

Clear, Frosted, Matte White, Opal, Smoked

**WOOD FINISHES**

Available in All Standard Wood Finishes

**MOUNTING HARDWARE DIAGRAM**

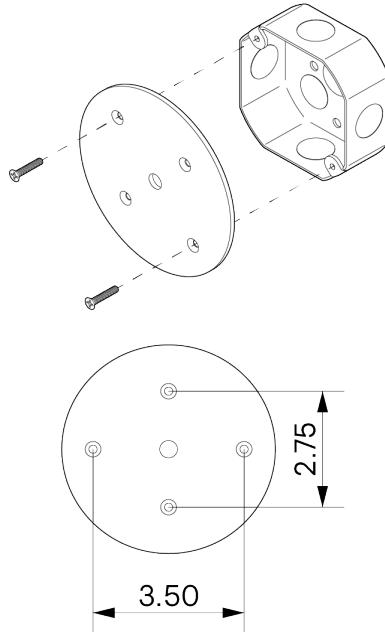

**MOUNTING**

Universal

**WEIGHT**

9.25 lb

**LAMPING**

E26 or E27 Screw Base. Type A Lamps

**BULB INCLUDED (120V USA)**

Cree 75W Bulb

**BULB INCLUDED (240V EU)**

Emery Allen 8.5W 240V Bulb

**LAMP QUANTITY**

1

**BRIGHTNESS**

1600 Lumens

**MAX WATTAGE**

20W

**DIMMING**

Universal

**DIMENSIONAL DRAWING**

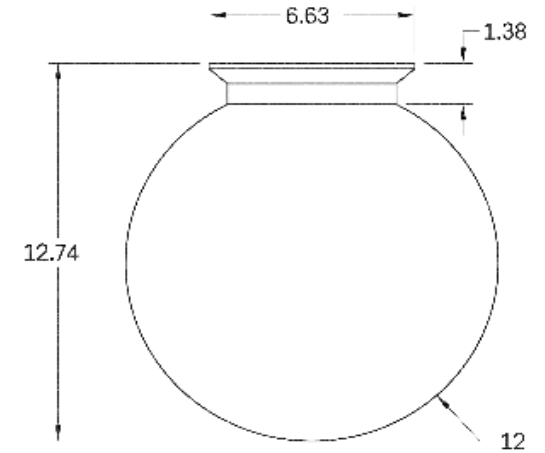

**CERTIFICATIONS**

CE, Damp Locations, Outdoor and Wet Locations, UL and cUL Certified

